

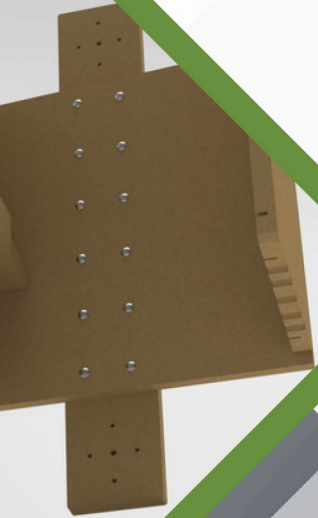

Squirrel Boxes

Sentinel Wachtower Installation Guide





D2 Camera Box

Exploded View

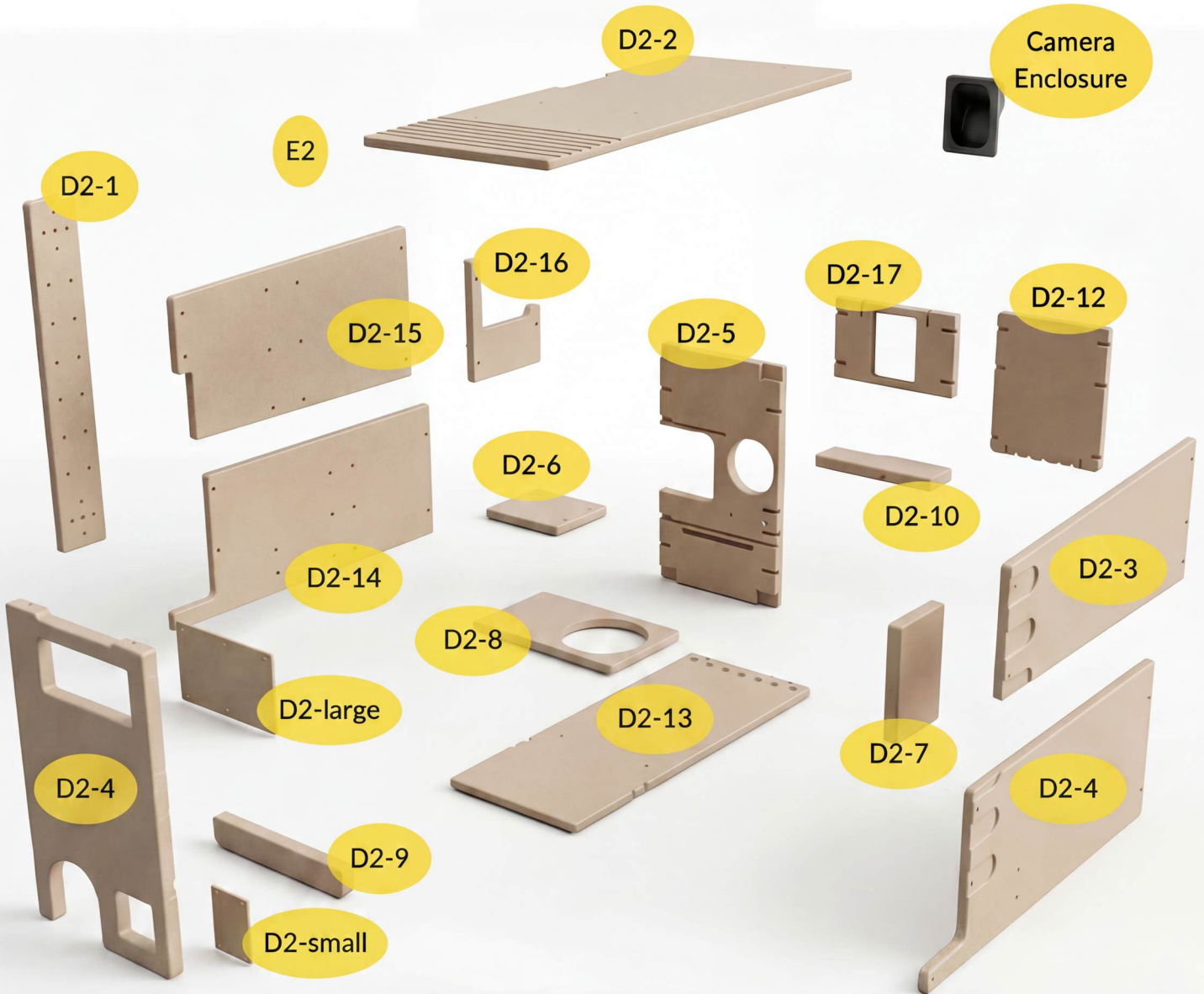

Camera enclosure part numbers:
SB-CAME-BLINK details: blink camera enclosure blink outdoor 2k / blink outdoor 4
SB-CAME-Google-nest-outdoor details: google nest outdoor camera enclosure
SB-CAME-ARI OP6 details: arlo pro 6 outdoor camera enclosure
SB-CAME-ARLOE details: arlo essentials outdoor camera enclosure
SB-CAME-ARLOGO2 details: arlo go2 outdoor camera enclosure
SB-CAME-RINGOP details: ring outdoor plus camera enclosure



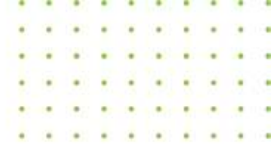

Installation Guide

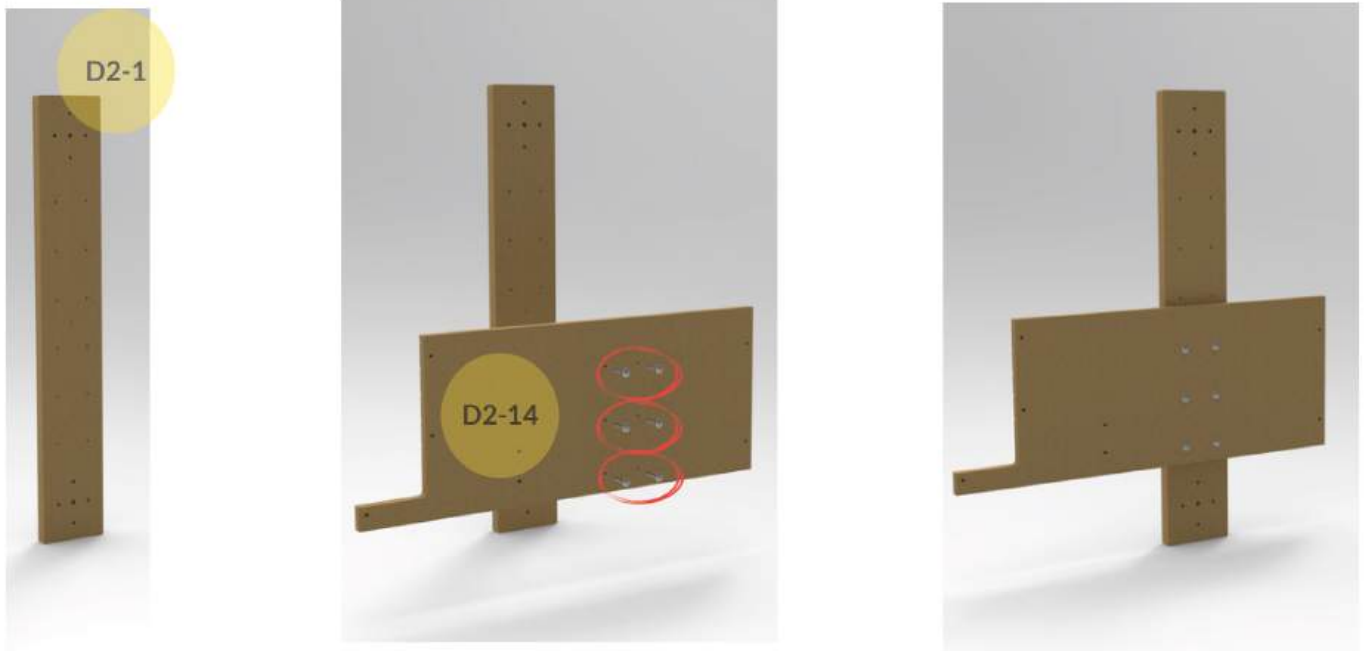

Attach part D2-14 to part D2-1

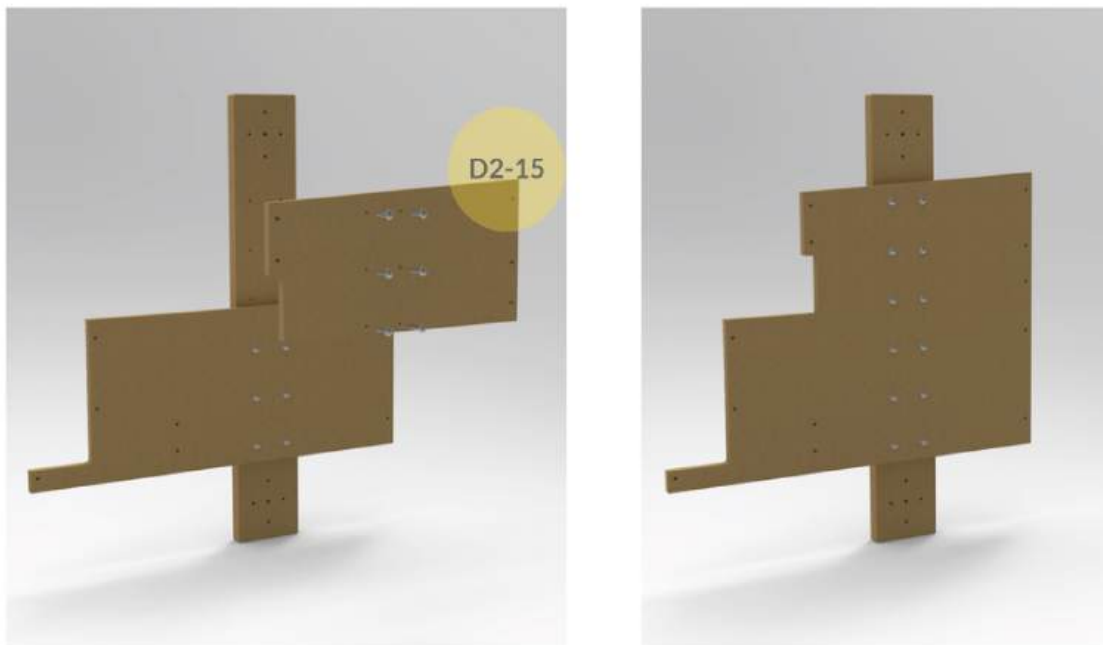

Attach part D2-15 to Assembly

Use 1 1/4 inch screws included



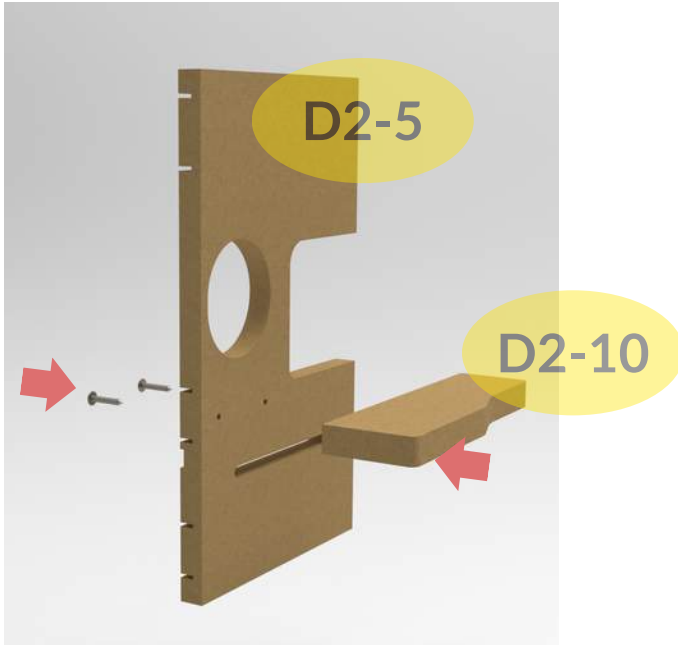

Screw the part D2-10 to D2-5



**Take off the protective blue film before installing the windows.
Attach the windows with small screws**

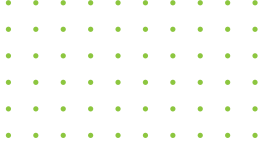

Installation Guide

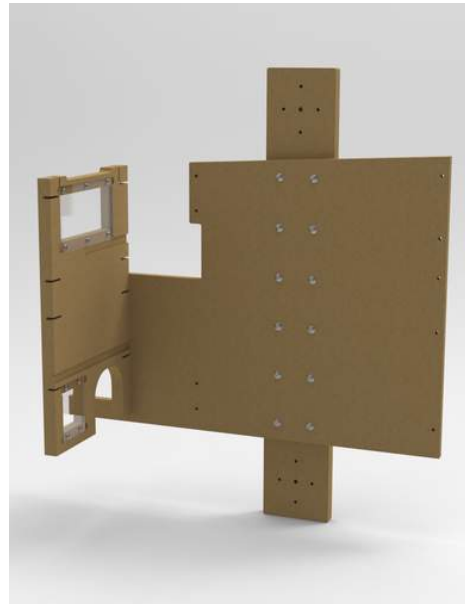
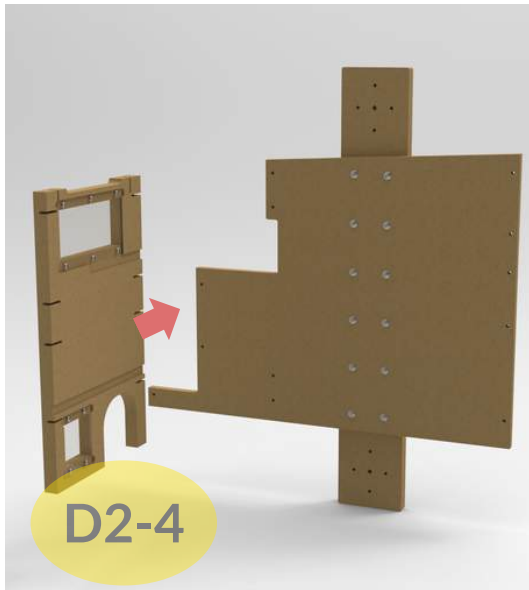

Attach D2-4 to assembly .

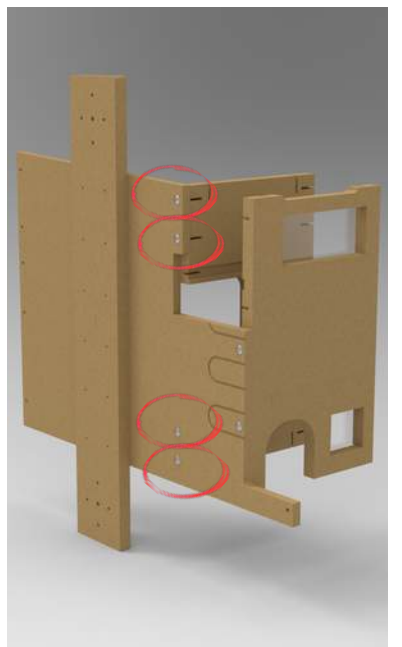
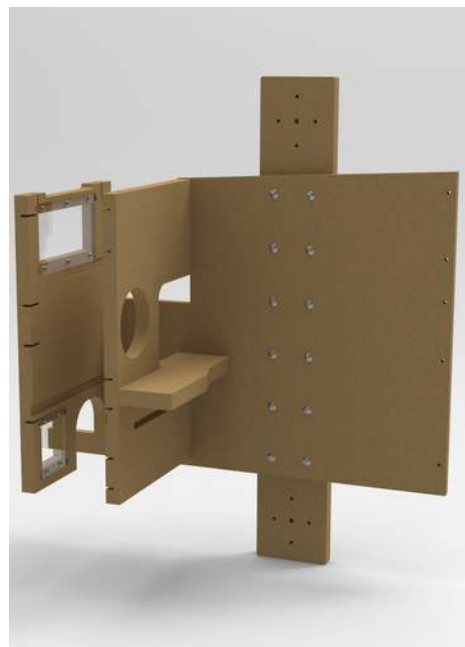

Screw the D2-5 Assembly to main assembly



Installation Guide

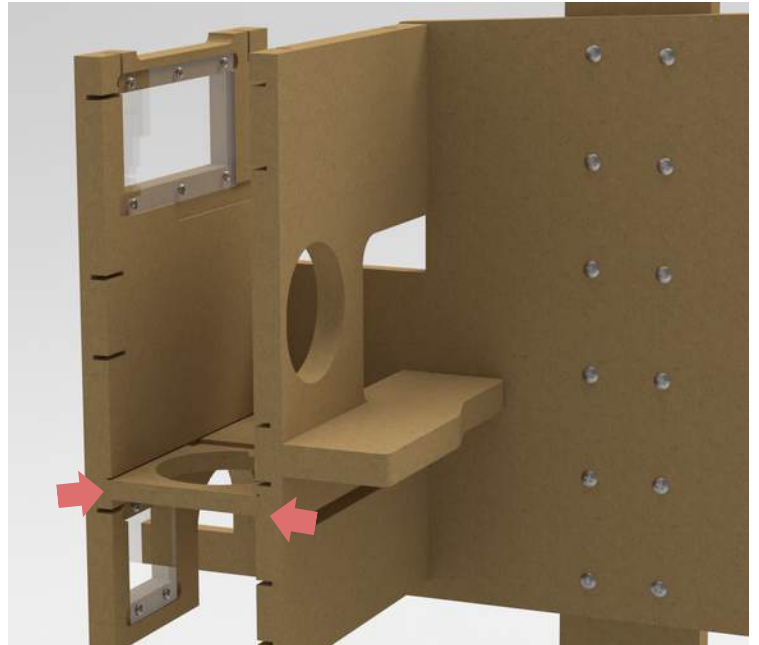
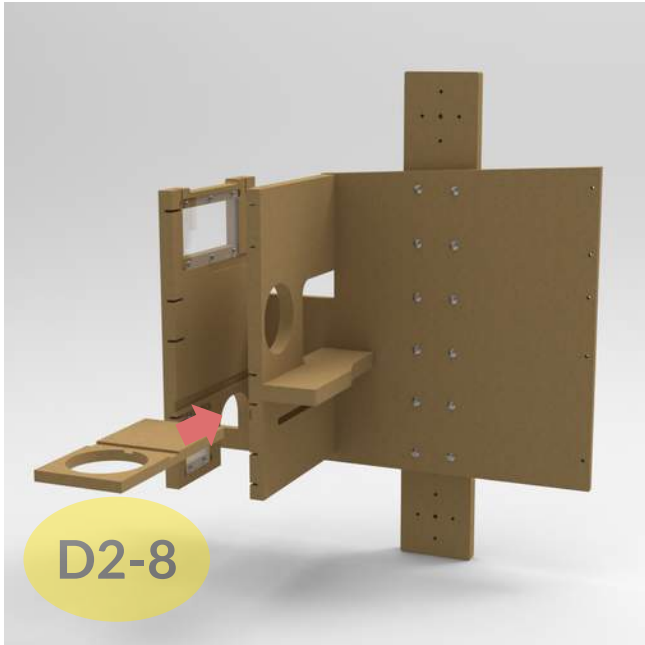

Slide D2-8 into assembly.

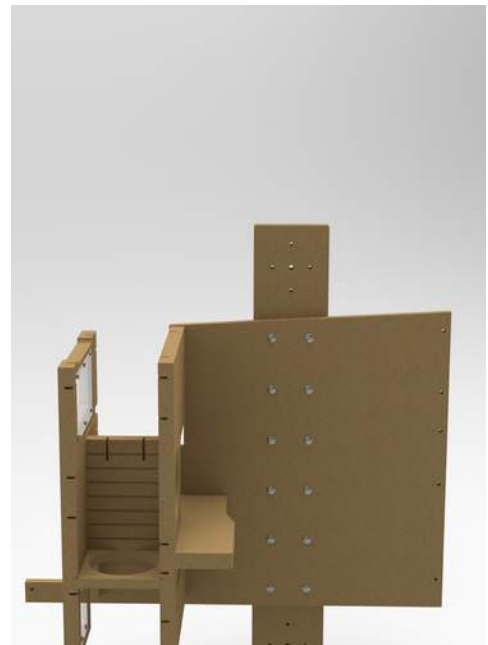
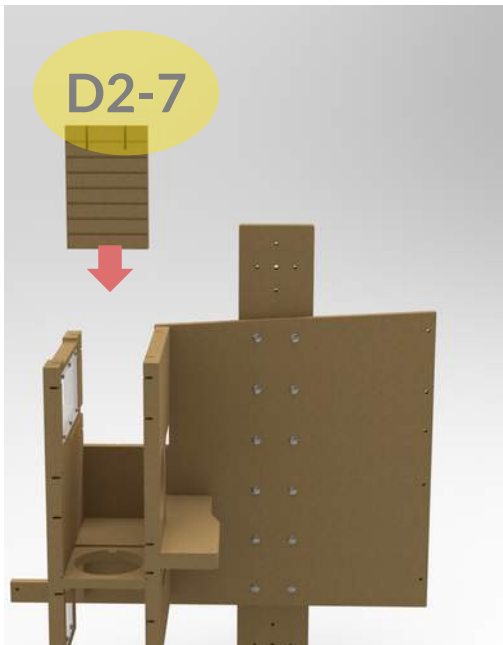

Slide D2-7 into assembly.



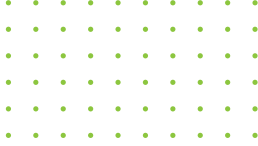

Installation Guide

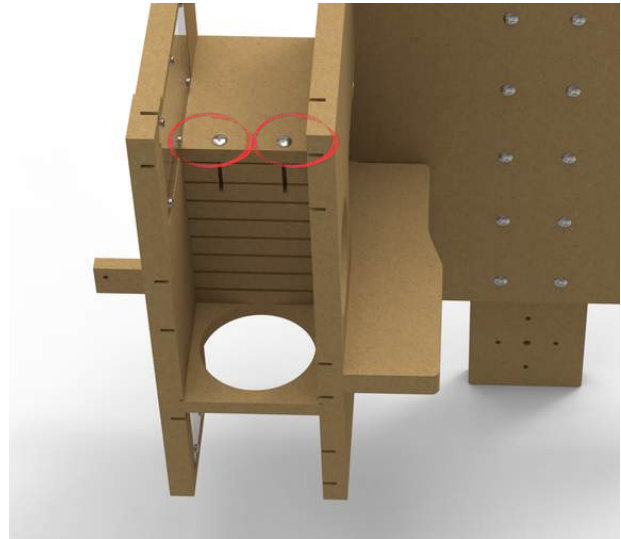

Slide D2-6 into assembly and screw to assembly.

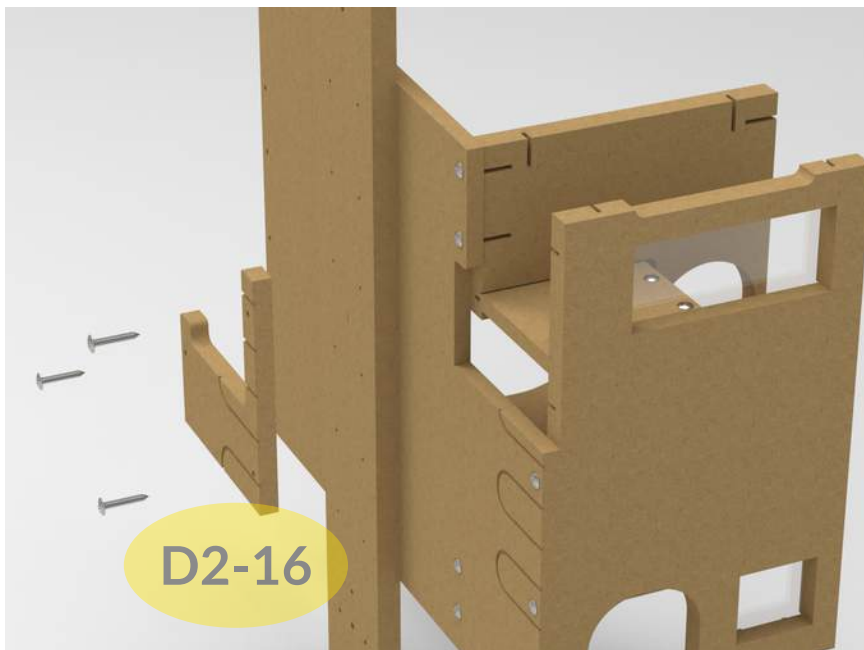

Screw D2-16 into assembly.





Installation Guide

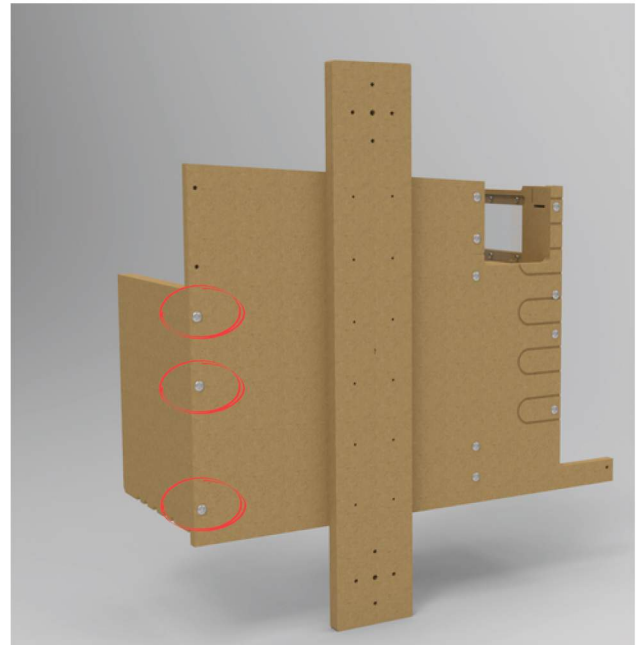
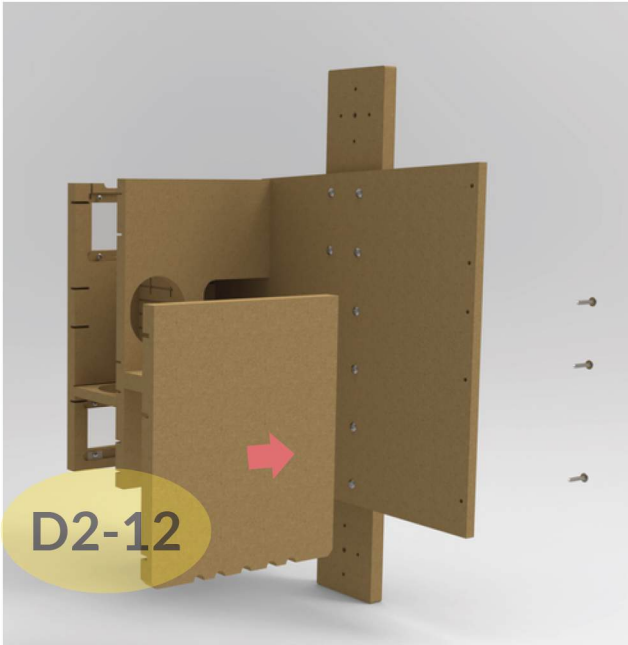

Screw D2-12 into assembly.

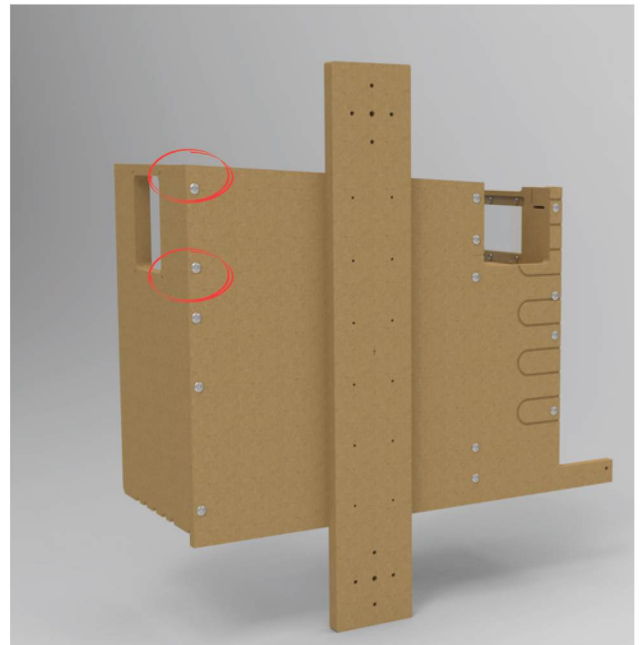
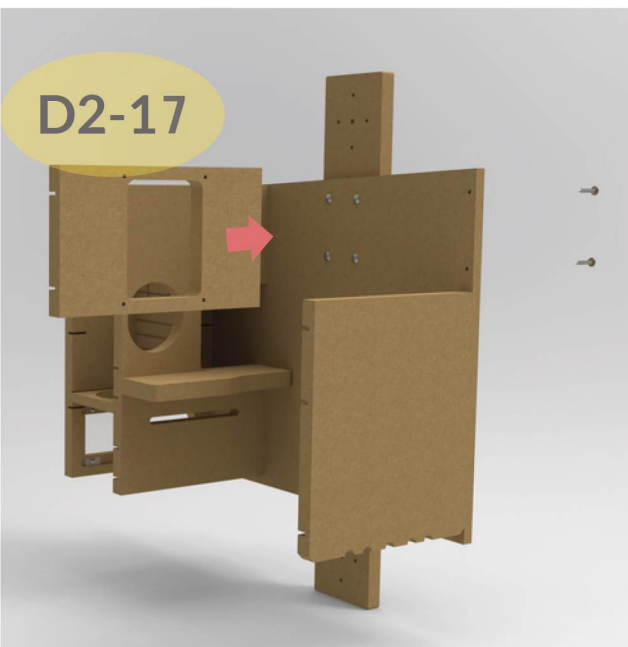

Screw D2-17 into assembly.



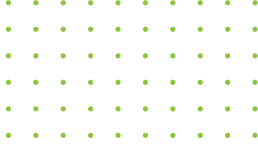

Installation Guide

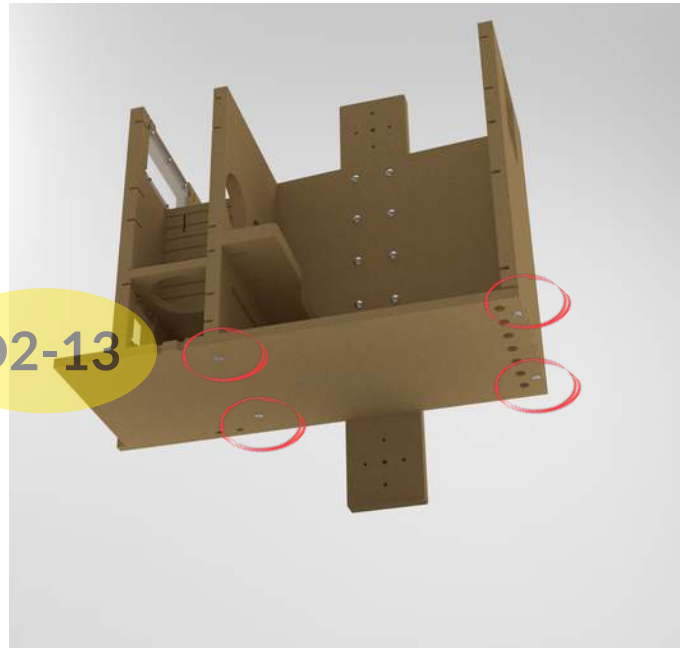
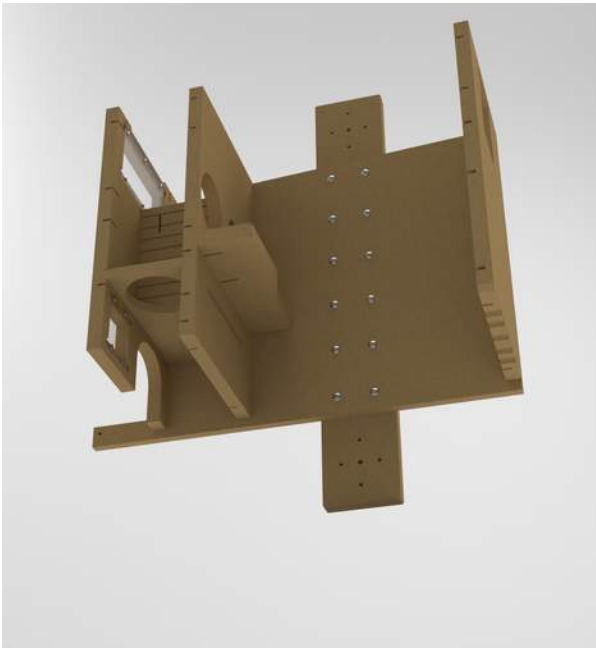

Screw D2-13 to bottom of assembly.

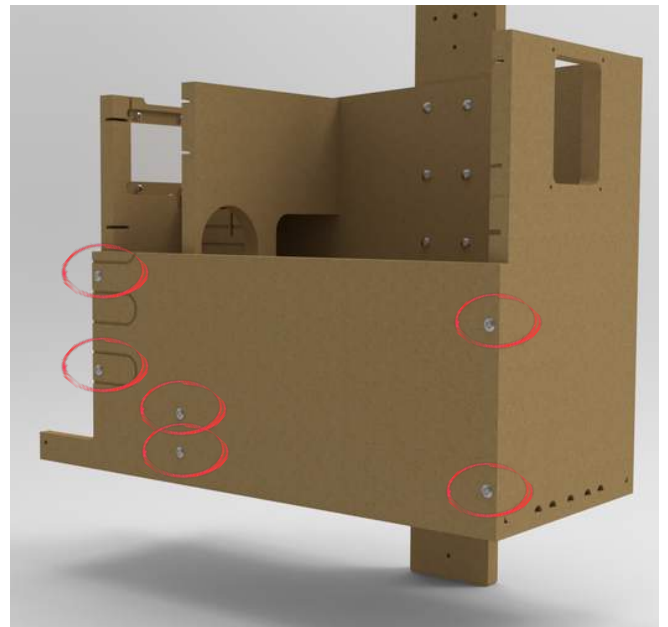
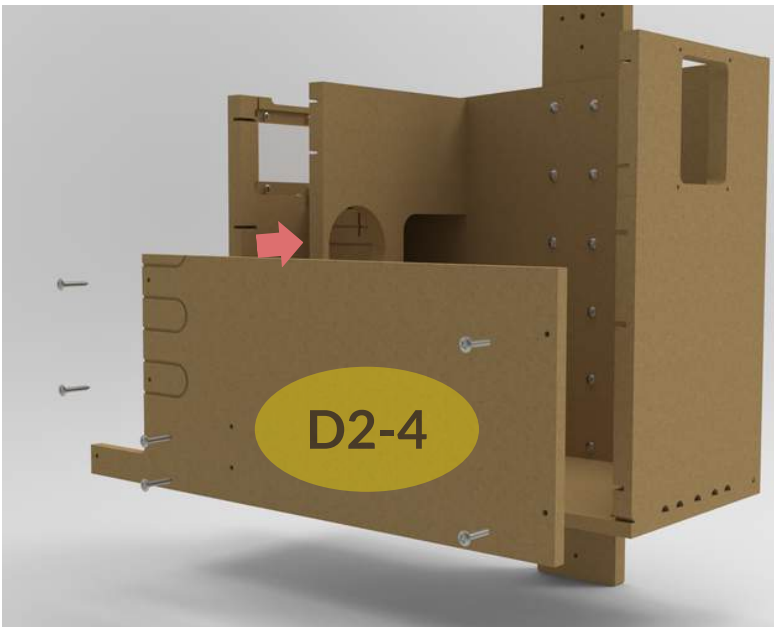

Screw D2-4 into assembly.





Installation Guide

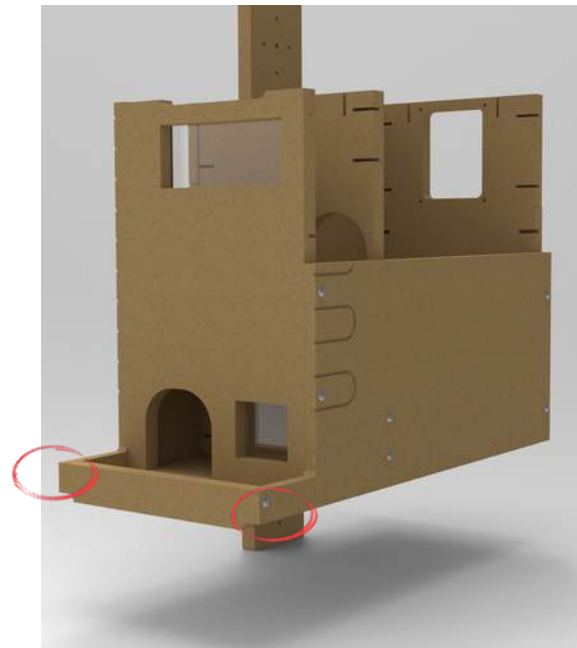
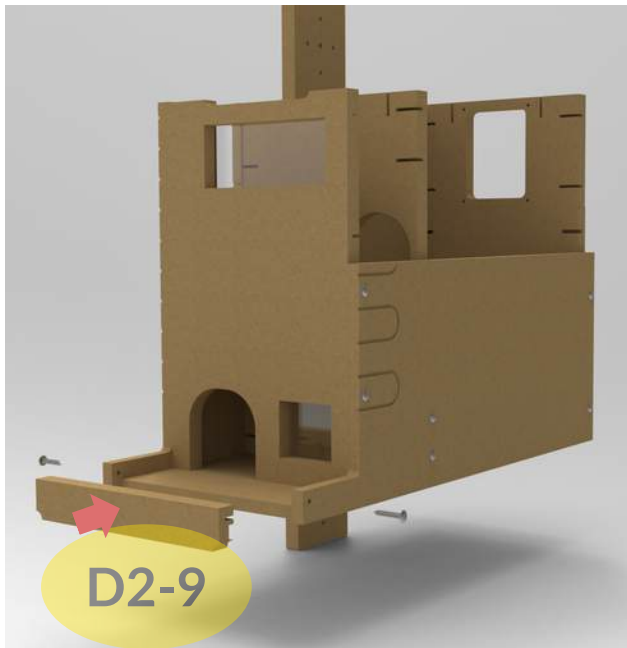

Screw D2-9 to bottom of assembly.

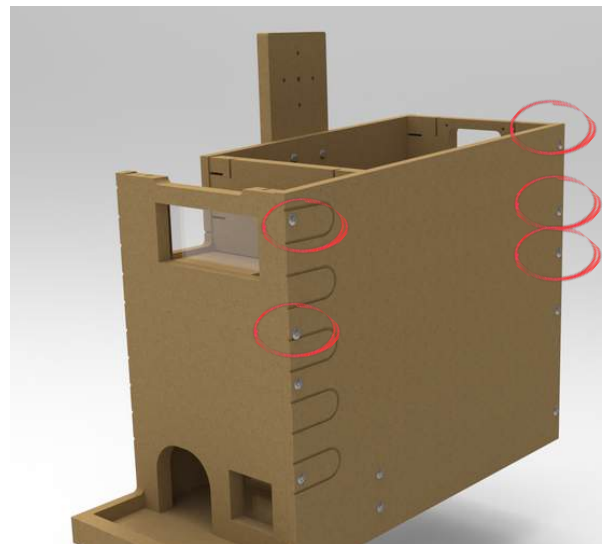
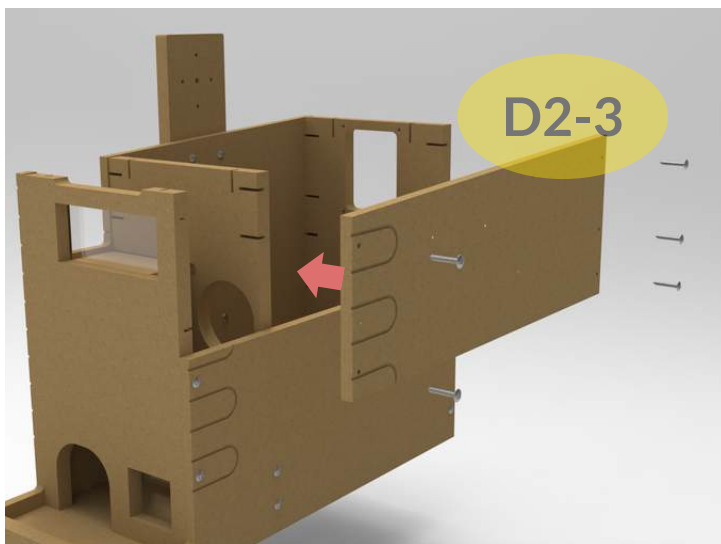

Screw D2-3 to assembly.





Installation Guide

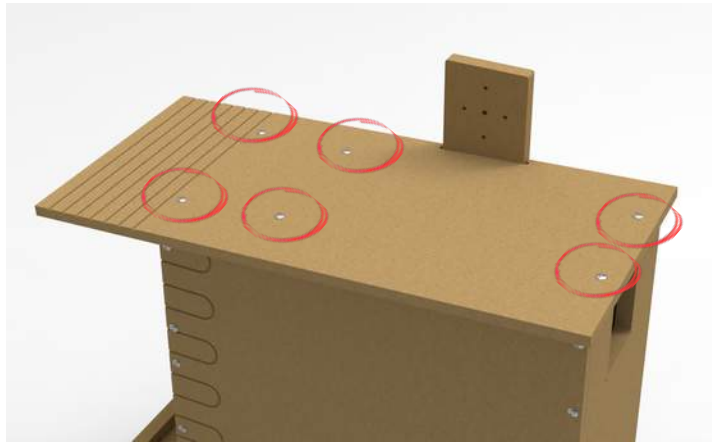
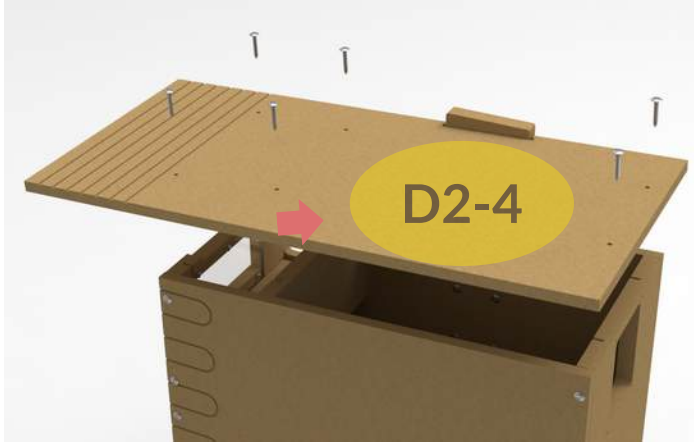

Screw D2-2 into assembly.

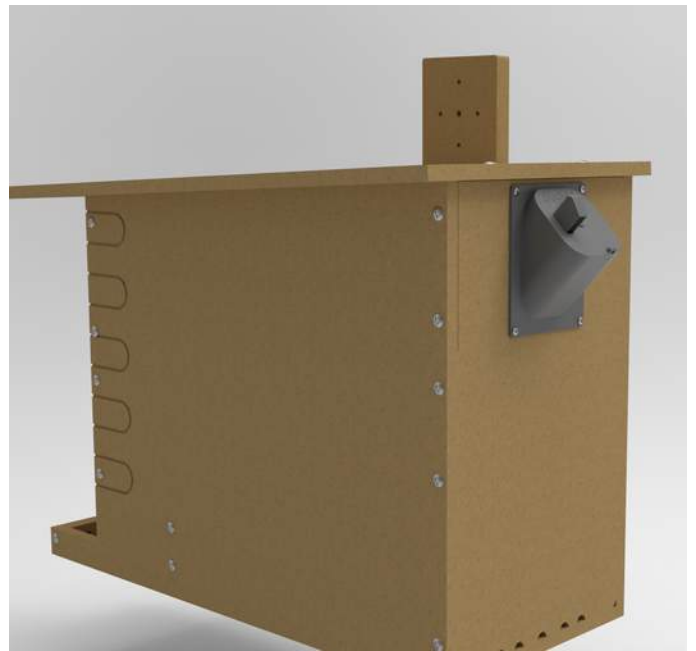
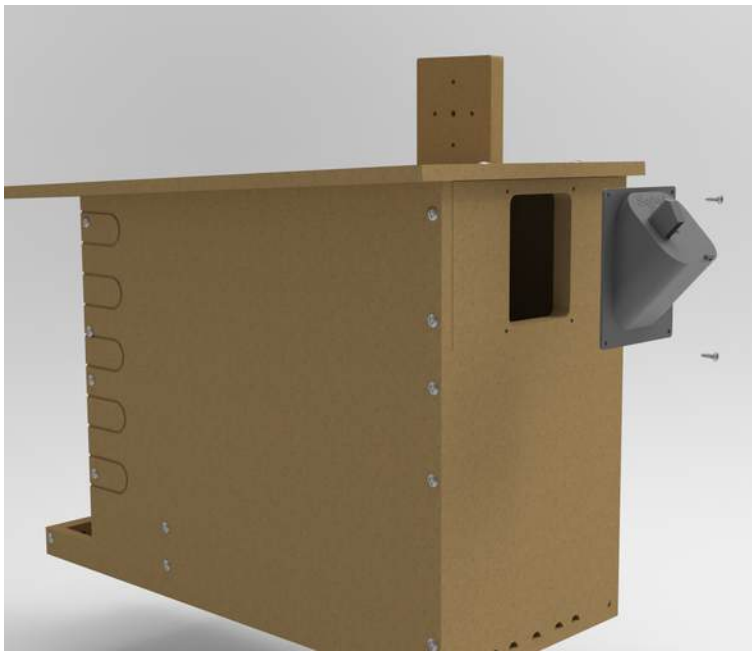

Screw the camera enclosure

